

TC7W00F, TC7W00FU, TC7W00FK

DUAL 2-INPUT NAND GATE

The TC7W00 is a high speed C²MOS 2-INPUT NAND GATE fabricated with silicon gate C²MOS technology. It achieves the high speed operation similar to equivalent LSTTL while maintaining the C²MOS low power dissipation.

The internal circuit is composed of 3 stages including buffer output, which enables high noise immunity and stable output.

All inputs are equipped with protection circuits against static discharge or transient excess voltage.

FEATURES

- High Speed $t_{pd} = 6ns$ (Typ.) at $V_{CC} = 5V$
- Low Power Dissipation $I_{CC} = 1\mu A$ (Max.) at $T_a = 25^\circ C$
- High Noise Immunity $V_{NIH} = V_{NIL} = 28\% V_{CC}$ (Min.)
- Output Drive Capability 10 LSTTL Loads
- Symmetrical Output Impedance ... $|I_{OH}| = I_{OL} = 4mA$ (Min.)
- Balanced Propagation Delays $t_{pLH} \approx t_{pHL}$
- Wide Operating Voltage Range ... $V_{CC} (opr) = 2\sim 6V$

MARKING

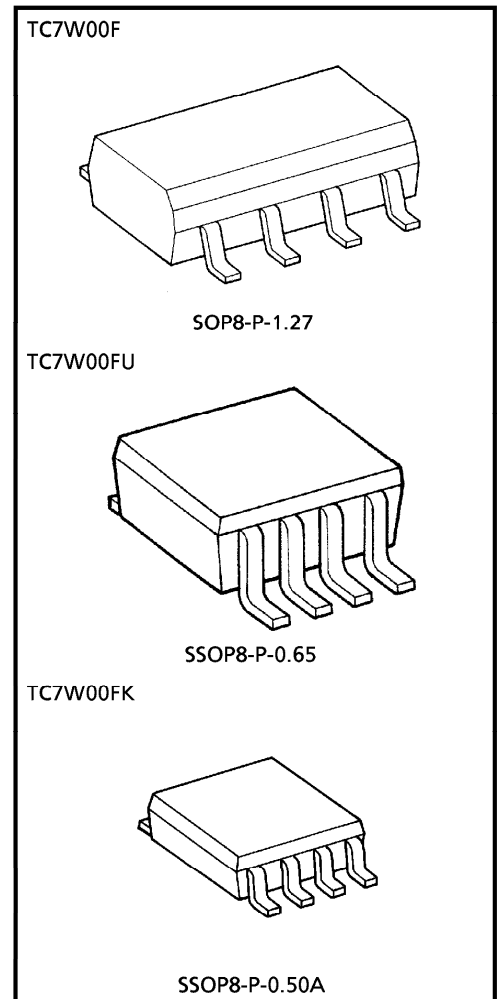
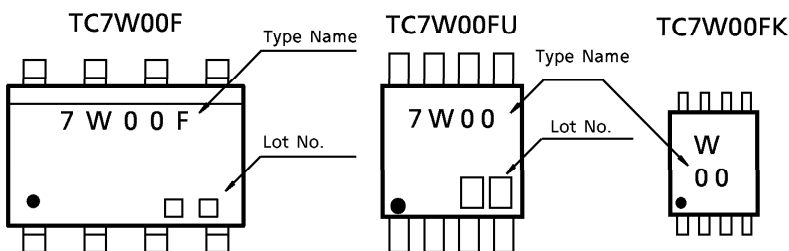

Weight

SOP8-P-1.27	: 0.05g (Typ.)
SSOP8-P-0.65	: 0.02g (Typ.)
SSOP8-P-0.50A	: 0.01g (Typ.)

MAXIMUM RATINGS (Ta = 25°C)

CHARACTERISTIC	SYMBOL	RATING	UNIT
Supply Voltage Range	V _{CC}	-0.5~7	V
DC Input Voltage	V _{IN}	-0.5~V _{CC} + 0.5	V
DC Output Voltage	V _{OUT}	-0.5~V _{CC} + 0.5	V
Input Diode Current	I _{IK}	± 20	mA
Output Diode Current	I _{OK}	± 20	mA
DC Output Current	I _{OUT}	± 25	mA
DC V _{CC} /Ground Current	I _{CC}	± 25	mA
Power Dissipation	P _D	300 (FM8, SM8)	mW
		200 (US8)	
Storage Temperature	T _{stg}	-65~150	°C
Lead Temperature (10s)	T _L	260	°C

LOGIC DIAGRAM

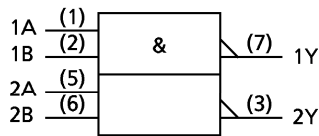

TRUTH TABLE

A	B	Y
L	L	H
L	H	H
H	L	H
H	H	L

PIN ASSIGNMENT (TOP VIEW)

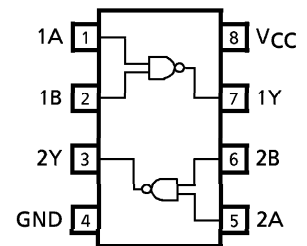

RECOMMENDED OPERATING CONDITIONS

CHARACTERISTIC	SYMBOL	RATING	UNIT
Supply Voltage	V _{CC}	2~6	V
Input Voltage	V _{IN}	0~V _{CC}	V
Output Voltage	V _{OUT}	0~V _{CC}	V
Operating Temperature	T _{opr}	-40~85	°C
Input Rise and Fall Time	t _r , t _f	0~1000 (V _{CC} = 2.0V)	ns
		0~ 500 (V _{CC} = 4.5V)	
		0~ 400 (V _{CC} = 6.0V)	

DC ELECTRICAL CHARACTERISTICS

CHARACTERISTIC	SYMBOL	TEST CONDITION		Ta = 25°C			Ta = -40~85°C		UNIT		
				V _{CC}	MIN.	TYP.	MAX.	MIN.		MAX.	
High-Level Input Voltage	V _{IH}	—		2.0	1.5	—	—	1.5	—	V	
				4.5	3.15	—	—	3.15	—		
				6.0	4.2	—	—	4.2	—		
Low-Level Input Voltage	V _{IL}	—		2.0	—	—	0.5	—	0.5	V	
				4.5	—	—	1.35	—	1.35		
				6.0	—	—	1.8	—	1.8		
High-Level Output Voltage	V _{OH}	V _{IN} = V _{IH} or V _{IL}		I _{OH} = -20μA	2.0	1.9	2.0	—	1.9	—	V
					4.5	4.4	4.5	—	4.4	—	
					6.0	5.9	6.0	—	5.9	—	
				I _{OH} = -4mA I _{OH} = -5.2mA	4.5	4.18	4.31	—	4.13	—	
6.0	5.68	5.80	—		5.63	—					
Low-Level Output Voltage	V _{OL}	V _{IN} = V _{IH}		I _{OL} = 20μA	2.0	—	0.0	0.1	—	0.1	V
					4.5	—	0.0	0.1	—	0.1	
					6.0	—	0.0	0.1	—	0.1	
				I _{OL} = 4mA I _{OL} = 5.2mA	4.5	—	0.17	0.26	—	0.33	
6.0	—	0.18	0.26		—	0.33					
Input Leakage Current	I _{IN}	V _{IN} = V _{CC} or GND		6.0	—	—	±0.1	—	±1.0	μA	
Quiescent Supply Current	I _{CC}	V _{IN} = V _{CC} or GND		6.0	—	—	1.0	—	10.0		

AC ELECTRICAL CHARACTERISTICS (C_L = 15pF, V_{CC} = 5V, Ta = 25°C)

CHARACTERISTIC	SYMBOL	TEST CONDITION	Ta = 25°C			UNIT
			MIN.	TYP.	MAX.	
Output Transition Time	t _{TLH}	—	—	4	8	ns
	t _{THL}					
Propagation Delay Time	t _{pLH}	—	—	6	12	ns
	t _{pHL}					

AC ELECTRICAL CHARACTERISTICS ($C_L = 50\text{pF}$, Input $t_r = t_f = 6\text{ns}$)

CHARACTERISTIC	SYMBOL	TEST CONDITION	Ta = 25°C			Ta = -40~85°C		UNIT	
			V _{CC}	MIN.	TYP.	MAX.	MIN.		MAX.
Output Transition Time	t _{TLH}	—	2.0	—	25	75	—	95	ns
	t _{THL}		4.5	—	7	15	—	19	
			6.0	—	6	13	—	16	
Propagation Delay Time	t _{pLH}	—	2.0	—	27	75	—	95	ns
	t _{pHL}		4.5	—	9	15	—	19	
			6.0	—	8	13	—	16	
Input Capacitance	C _{IN}	—	—	5	10	—	10	pF	
Power Dissipation Capacitance	C _{pD}	(Note 1)	—	20	—	—	—		

(Note 1) C_{pD} is defined as the value of internal equivalent capacitance of IC which is calculated from the operating current consumption without load (refer to Test Circuit).

Average operating current can be obtained by the equation hereunder.

$$I_{CC(opr)} = C_{pD} \cdot V_{CC} \cdot f_{IN} + I_{CC} / 2 \text{ (per gate)}$$

PACKAGE DIMENSIONS
SOP8-P-1.27

Unit : mm

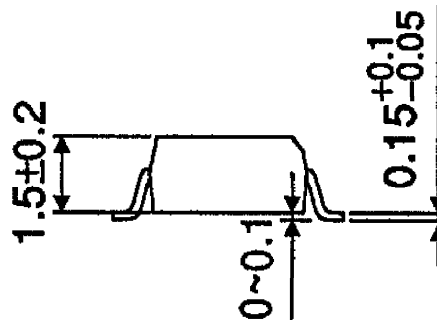
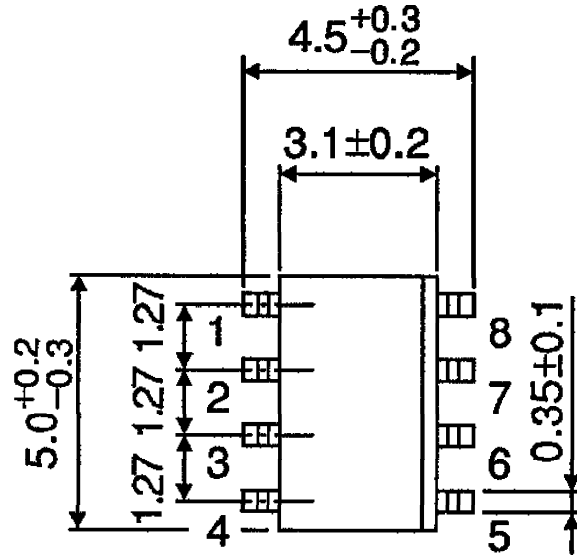

Weight : 0.05g (Typ.)

PACKAGE DIMENSIONS
SSOP8-P-0.65

Unit : mm

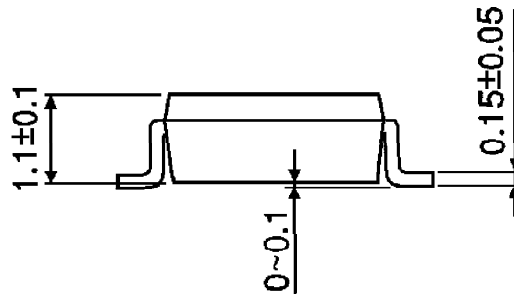
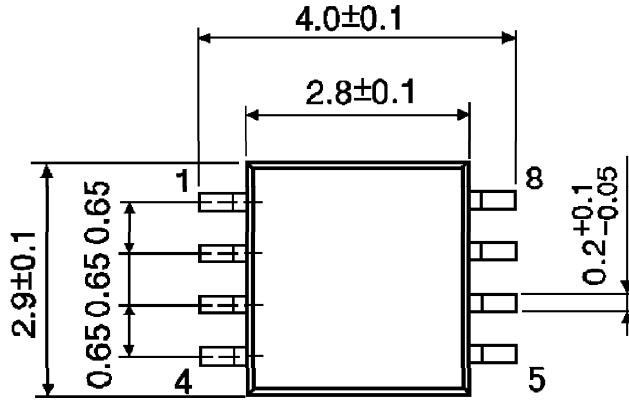

Weight : 0.02g (Typ.)

PACKAGE DIMENSIONS
SSOP8-P-0.50A

Unit : mm

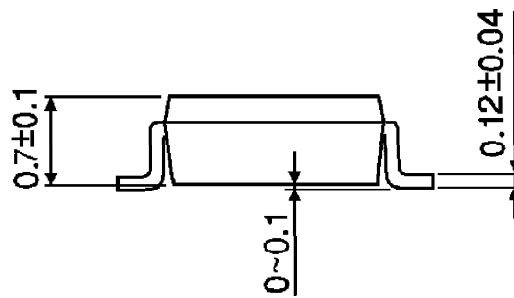
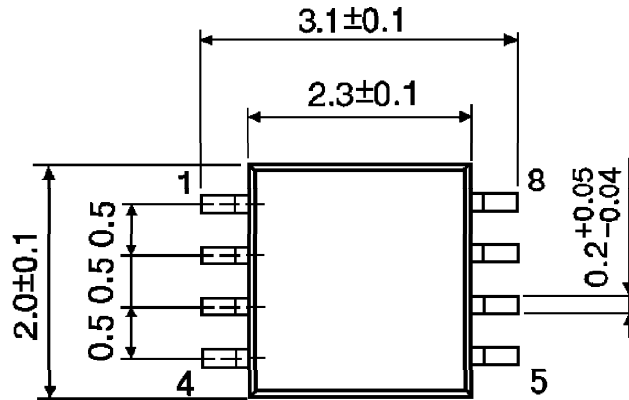

Weight : 0.01g (Typ.)

RESTRICTIONS ON PRODUCT USE

000707EBA

- TOSHIBA is continually working to improve the quality and reliability of its products. Nevertheless, semiconductor devices in general can malfunction or fail due to their inherent electrical sensitivity and vulnerability to physical stress. It is the responsibility of the buyer, when utilizing TOSHIBA products, to comply with the standards of safety in making a safe design for the entire system, and to avoid situations in which a malfunction or failure of such TOSHIBA products could cause loss of human life, bodily injury or damage to property. In developing your designs, please ensure that TOSHIBA products are used within specified operating ranges as set forth in the most recent TOSHIBA products specifications. Also, please keep in mind the precautions and conditions set forth in the "Handling Guide for Semiconductor Devices," or "TOSHIBA Semiconductor Reliability Handbook" etc..
- The TOSHIBA products listed in this document are intended for usage in general electronics applications (computer, personal equipment, office equipment, measuring equipment, industrial robotics, domestic appliances, etc.). These TOSHIBA products are neither intended nor warranted for usage in equipment that requires extraordinarily high quality and/or reliability or a malfunction or failure of which may cause loss of human life or bodily injury ("Unintended Usage"). Unintended Usage include atomic energy control instruments, airplane or spaceship instruments, transportation instruments, traffic signal instruments, combustion control instruments, medical instruments, all types of safety devices, etc.. Unintended Usage of TOSHIBA products listed in this document shall be made at the customer's own risk.
- The products described in this document are subject to the foreign exchange and foreign trade laws.
- The information contained herein is presented only as a guide for the applications of our products. No responsibility is assumed by TOSHIBA CORPORATION for any infringements of intellectual property or other rights of the third parties which may result from its use. No license is granted by implication or otherwise under any intellectual property or other rights of TOSHIBA CORPORATION or others.
- The information contained herein is subject to change without notice.